

BASIC RULES OF PACKAGING

What does the package have to endure during the transportation?

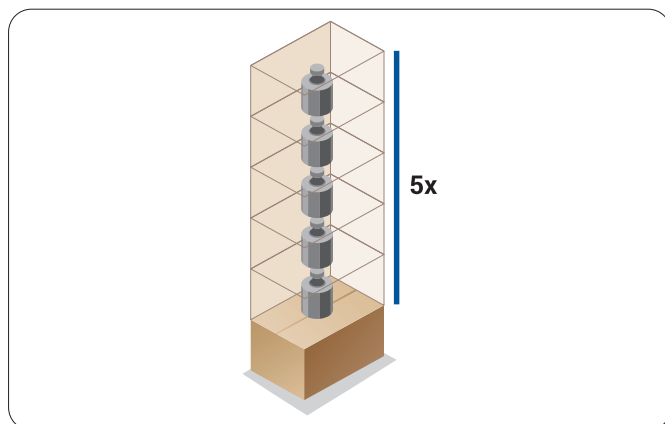

The test of the firmness of the package:
the package with the product must endure 5x of its weight

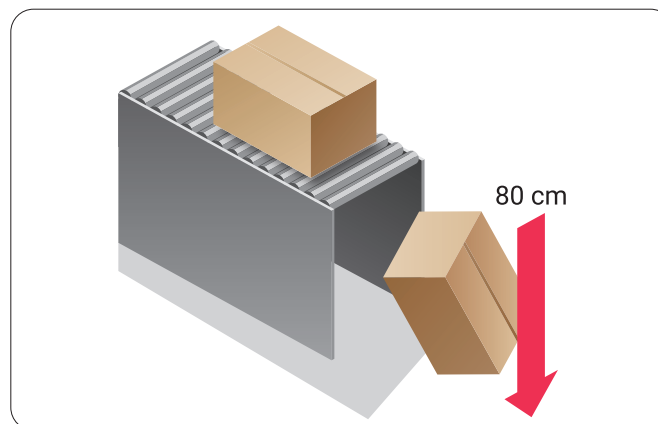

The falling crash test: free fall from 60-80 cm for weight 0-30 kg (ČSN EN 22248 and ČSN EN ISO 24180-20)

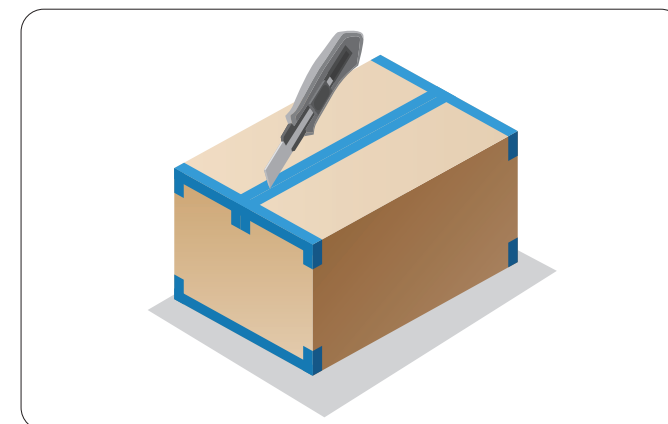

Original packaging security: using the company costumed tapes

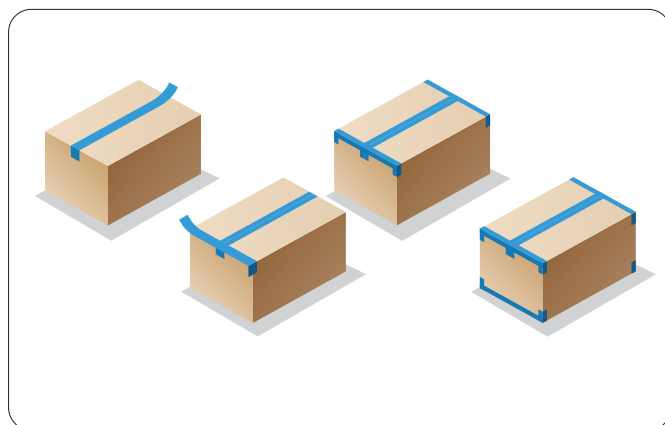

The right taping of the consignment:
the shape of double "H"

PRINCIPLES:

- use only good quality packaging materials
- protect the surface and sensitive parts of the product
- separate and interpolate each product
- eliminate shifting and moving of the product
- create deformation zones on all sides
- fill the boxes with filling materials up to the top
- the whole package must be firm and compact
- if needed use the manipulation signs

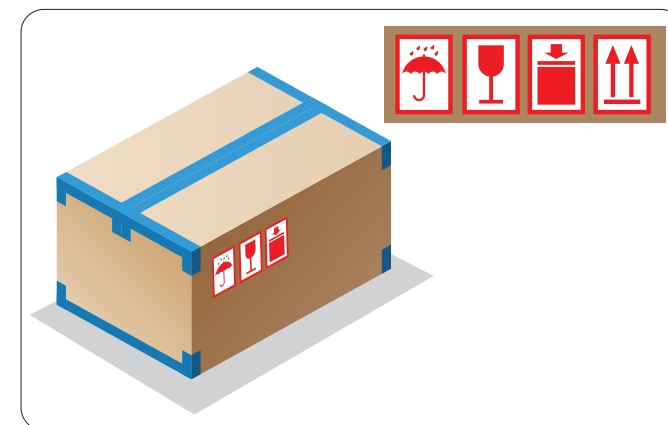

Manipulation signs: do not substitute good quality packaging and filling (ČSN EN ISO 780). The consignment is labeled with just one PPL Label!

SUITABLE TRANSPORT COVERS

Security of the content, crash protection, firmness and compactness, deformation zones

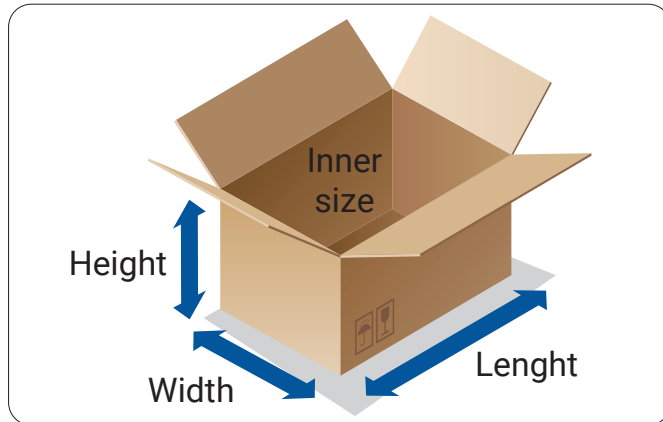

Boxes of corrugated board:
quality - firmness - stability - compactness



Post boxes of corrugated board

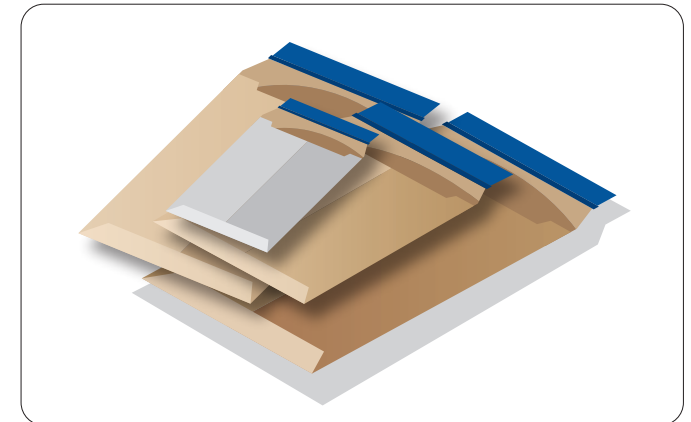

Security envelopes

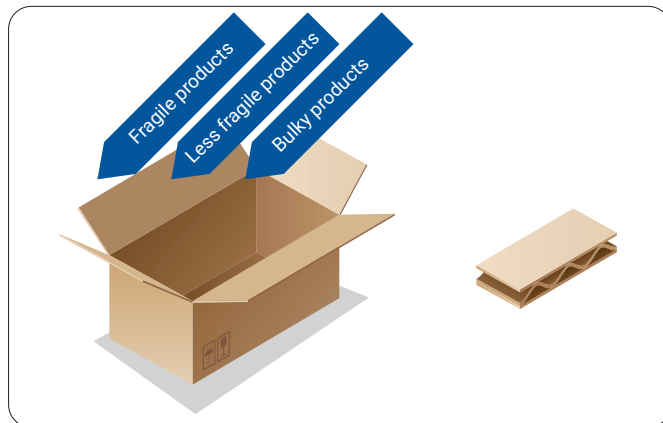

Threewall cardboard
(of various level quality)

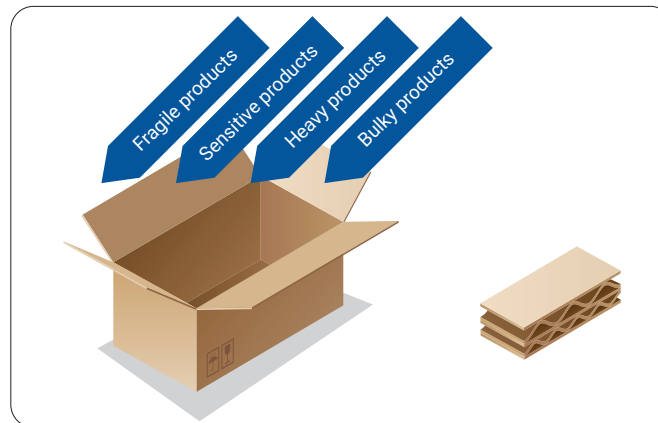

Fivewall cardboard
(of various level quality)

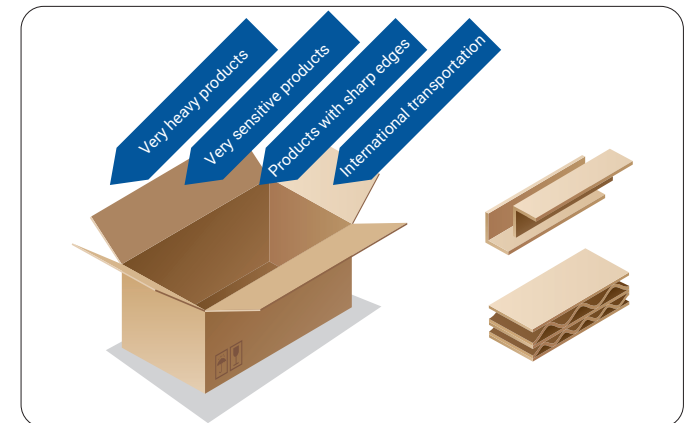

Using of special L-shaped or U-shaped tendons in corners and sides

PRODUCT FEATURES AND TRANSPORT RESTRICTION

Division according to sensitivity and features



Fragile products: glass, porcelain, ceramics, etc.

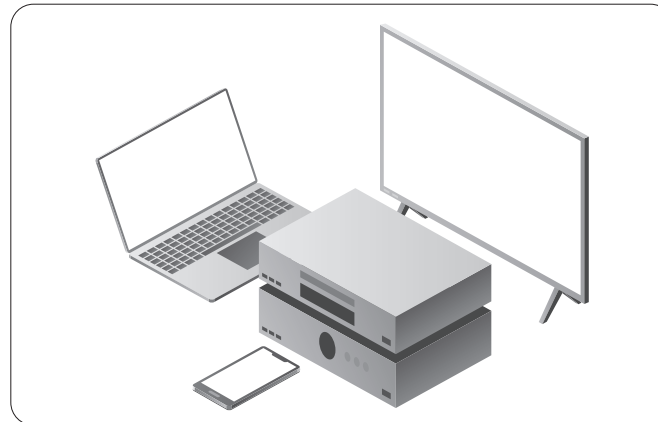

Sensitive products: mechanical and optical gadgets, electronics, etc.

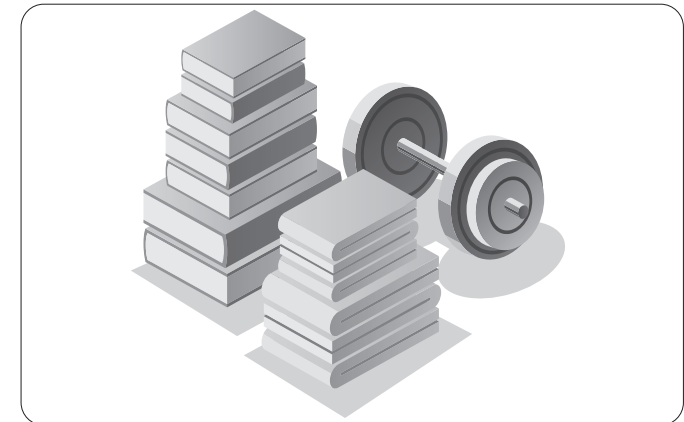

Robust products: books, metal parts, textile, etc.



Maximal weight of the consignment is 31,5 kg:
consignment must be manipulated by 1 person only

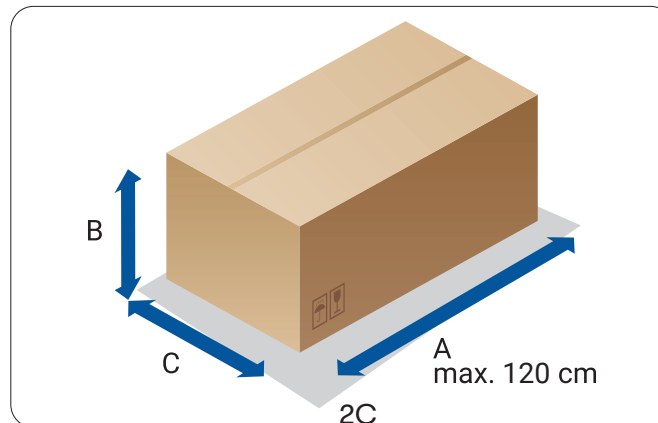

Maximal size of the consignment: Length: 120 x 60 x 60 cm
Size: $A + 2B + 2C = \text{max. } 360 \text{ cm}$



The consignment must not contain explosives, weapons, flammable, or chemical substances.
(see the transport conditions of PPL)

TRANSPORT CONDITIONS AND RISK

Manipulation with the consignment: 6-8x loading, unloading and transportation using the conveyor belt

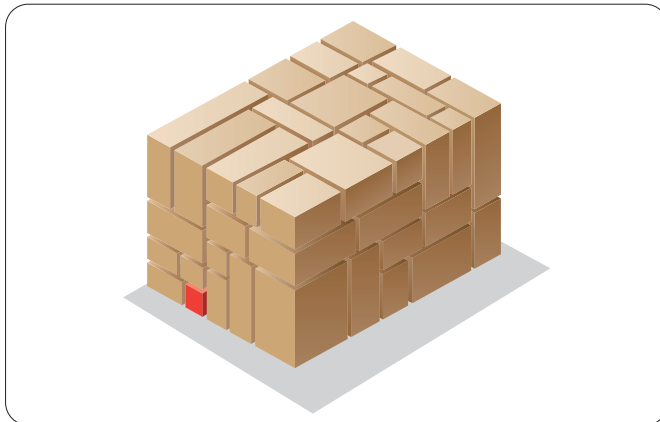

Pressure: your consignment can be up to 2,5 m under the pile

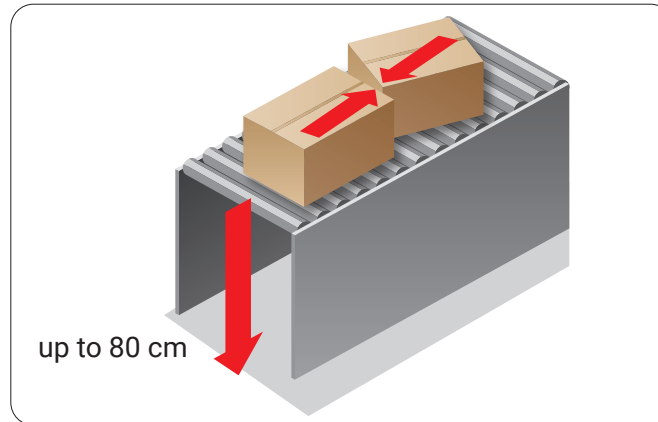

Crashes and falls: during the manipulation on the conveyor belt, up to 80 cm

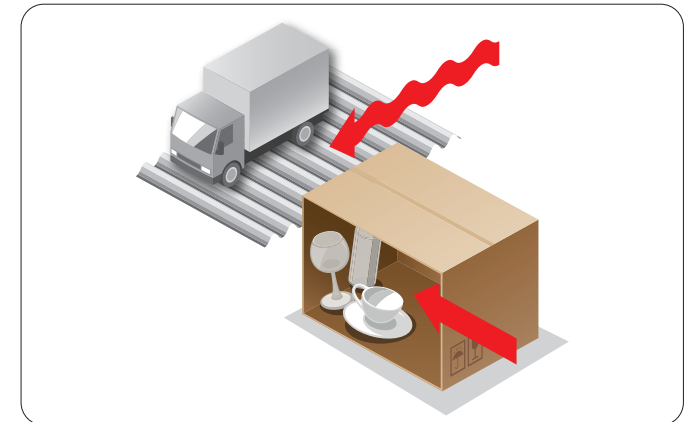

Vibration: the content of the consignment can be moved to the side within the package

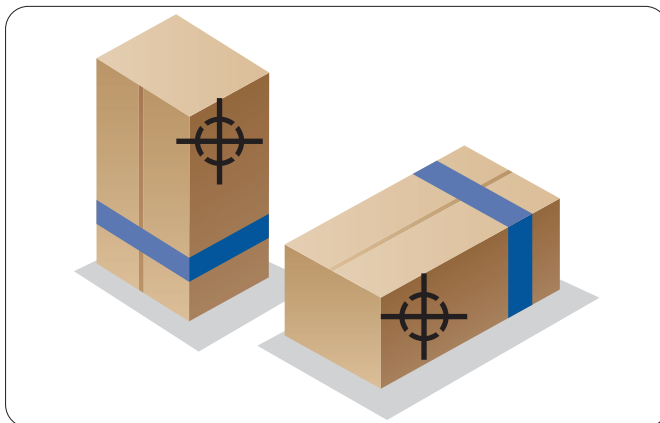

The centroid: your consignment will be transported in the most stable position



It is not possible to tie, tape, join by stretch foil or stick the consignments. Consignments attached to each other do not enable manipulation and can be torn.



The consignment must be labeled with one PPL label.

INNER FILLING AND FIXATION

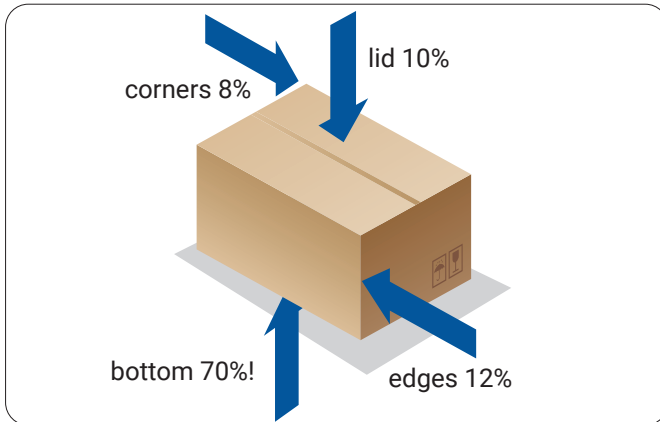

The risk of falling of the transported consignment in percentage



Product with no inner filling:
the risk of damage is very high!

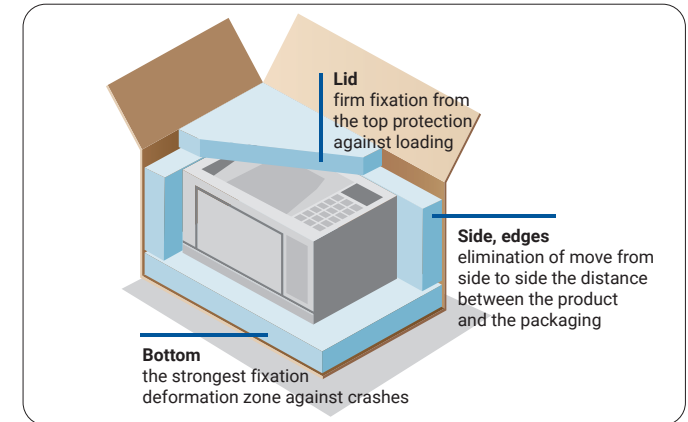

Form deformation zones:
use fixing and filling materials

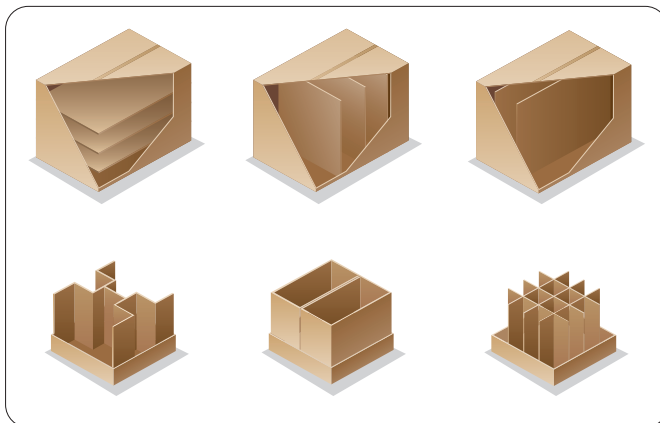

Separation of the products:
elimination of damage (grids, curves, and packaging)

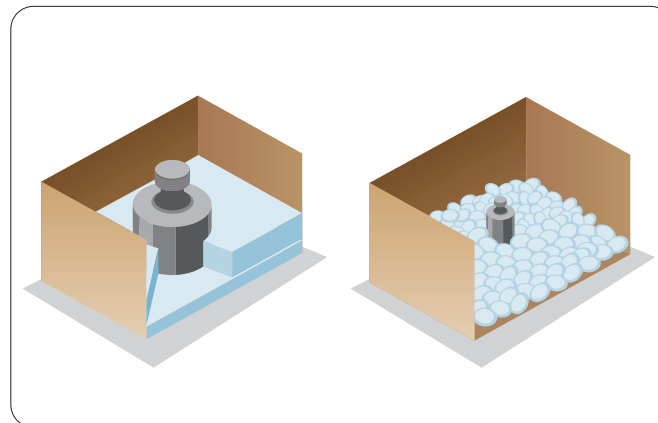

Light products: soft and airy fixation
Heavy products: rigid and firm fixation

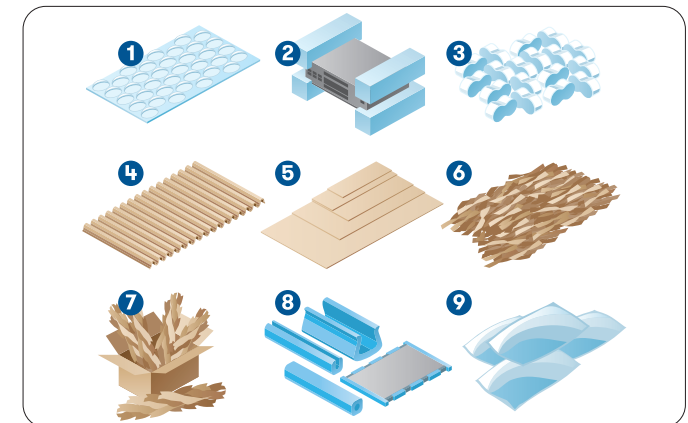

Various kinds of fixation: 1. bubble foil 2. polystyrene fixation 3. flopak pieces 4. cardboard 5. cardboard curves 6. kartofix 7. padpak 8. foam profiles 9. cello airy bags